

Trapezoidal and Corrugated Profiles

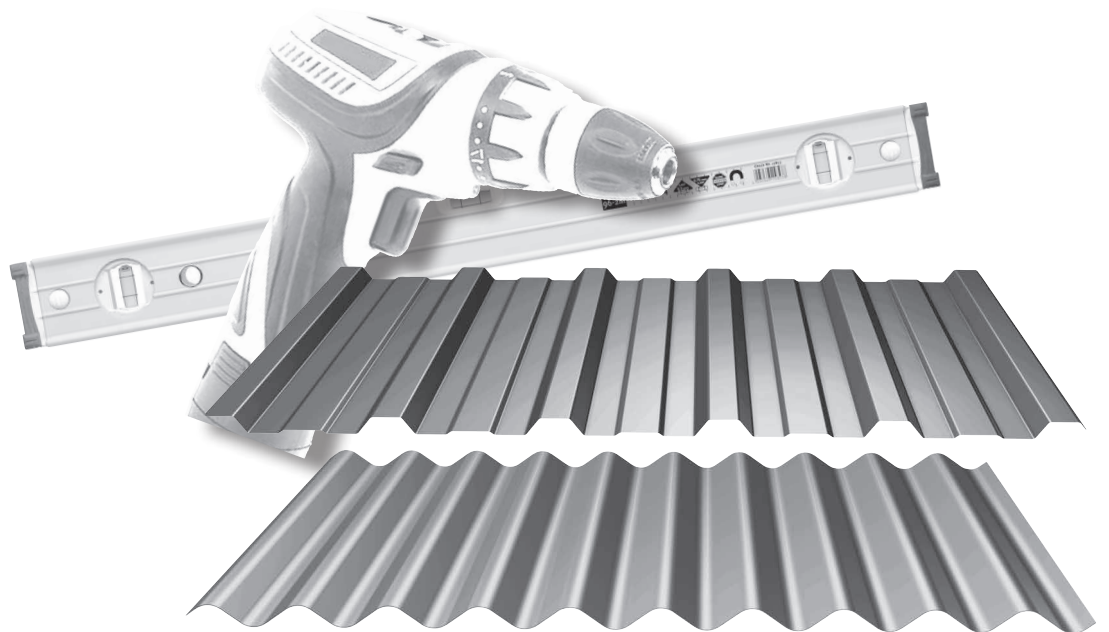

Range of Profiles	Page
Trapezoidal Profiles _____	4
Corrugated Profiles _____	5
 General	
Transport, Storage, Protective Foil _____	6
Preparation for installation, Substructure, Distances of Supports and Aligning, Installation Direction and Order, Cleaning and Repair _____	7
Translucent Roofing Panels, Ridges _____	8
Wall Installation, Arrangement of Profiles, Shaped Parts and Detailed Solutions, Mounting at the Verge and the Ridge _____	9
 Steel Profiles: Special Features	
Processing Steel Profiles, Longitudinal Joints, Transverse Joints _____	10
 Aluminium Profiles: Special Features	
Specific Instructions, Processing Aluminium Profiles, Roof Pitch, Longitudinal Joints, Transverse Joints, Accessibility and Safety _____	11
 Fixing Patterns	
Fixing Patterns for Trapezoidal and Corrugated Profiles / Roof and Wall, Fastening at the bottom chord, Fastening at the top chord _____	12
Trapezoidal Profile 20 - 75 Trapezoidal Profile 40 - 100 Trapezoidal Profile 18 - 224 Wall Profile _____	13
Trapezoidal Profile 22 - 214 Trapezoidal Profile 35 - 207 Roof Profile Trapezoidal Profile 35 - 207 Wall Profile _____	14
Trapezoidal Profile 45 - 333 S Trapezoidal Profile 50 - 250 Roof Profile _____	15
Corrugated Profile 18 / 76 Corrugated Profile 27 / 111 _____	16
Corrugated Profile 42 / 160 Corrugated Profile 55 / 177 _____	17
 Table of Screws	
Fastening at the top chord _____	18
Fastening at the bottom chord _____	19

Trapezoidal Profiles

Trapezoidal Profile 20 - 75

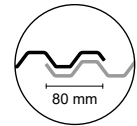

Trapezoidal Profile 40 - 100

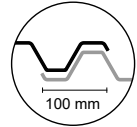
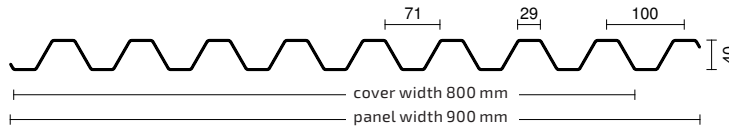

Trapezoidal Profile 18 - 224
for the wall

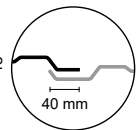
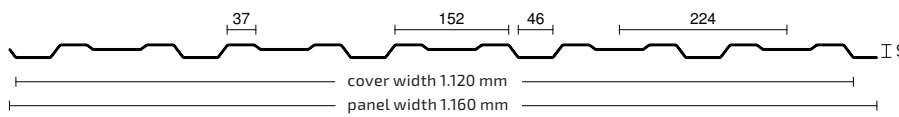

Trapezoidal Profile 22 - 214

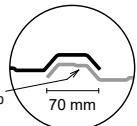
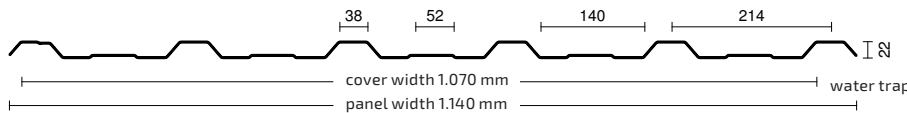

Trapezoidal Profile 35 - 207
for the roof

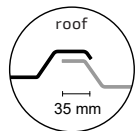
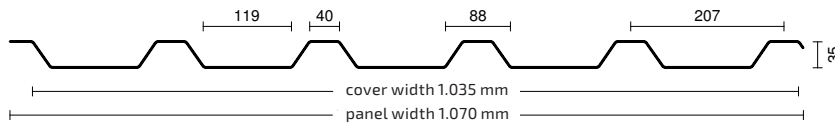

Trapezoidal Profile 35 - 207
for the wall
also available without center corrugation

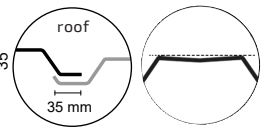
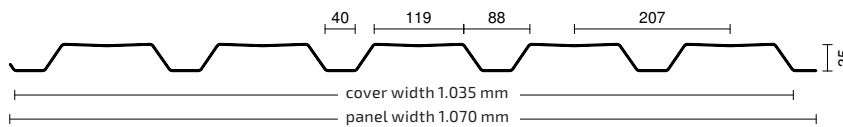

On request, also available without center corrugation

Trapezoidal Profile 45 - 333 S

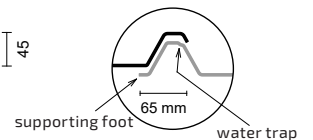
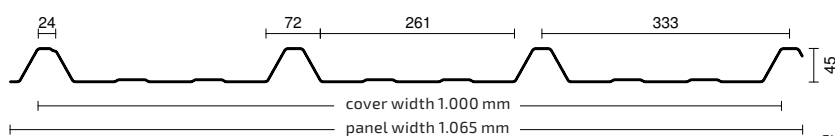

Trapezoidal Profile 50 - 250

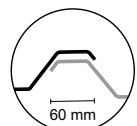
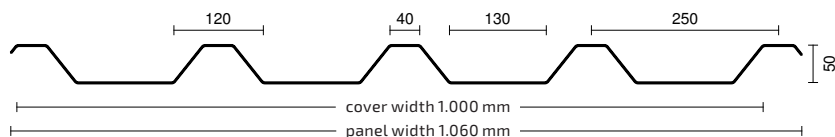

Corrugated Profiles

Corrugated Profile 18 / 76

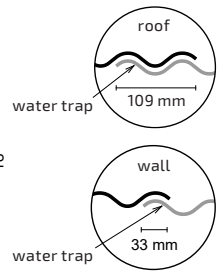
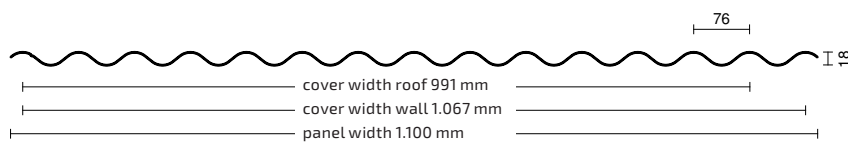

Corrugated Profile 27 / 111

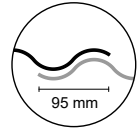
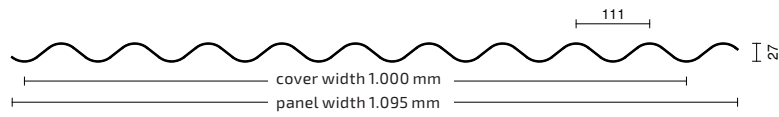

Corrugated Profile 42 / 160

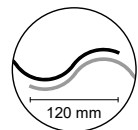
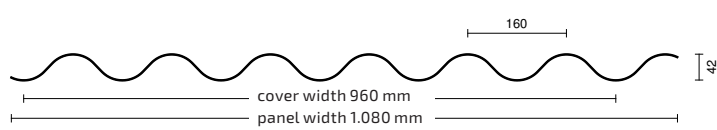

Corrugated Profile 55 / 177

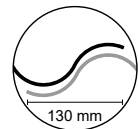
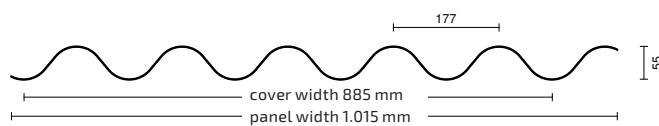

Potential combination of metals

The table shows which combinations are possible (•) or not possible (-):

	AL	Pb	Cu	Zn	VA	St	AZ
AL	•	•	-	•	•	•	•
Pb	•	•	•	•	•	•	-
Cu	-	•	•	-	•	-	-
Zn	•	•	-	•	•	•	•
VA	•	•	•	•	•	•	•
St	•	•	-	•	•	•	•
AZ	•	-	-	•	•	•	•

- AL = aluminium
- Pb = lead
- Cu = copper and copper alloys respectively
- Zn = titanium-zinc
- VA = stainless steel
- St = hot-dip galvanised steel
- AZ = Aluzinc

Combination of metals with other materials

Wood

To avoid any chemical reaction an intermediate layer is recommended when assembling metal parts with wood. Here it does not matter whether the wooden parts are untreated or impregnated. Exceptions can only be made when expressly approved by the manufacturer.

Concrete and masonry

Concrete or masonry surfaces must also be covered by suitable separating layers such as fabric layers, plastics or similar materials before metal profiles are put on them to prevent attacks by alkaline substances.

Transport

Suitable forklift trucks or cranes (perhaps with cross beams) are to be used when loading or unloading profiles. To avoid damages to the panels they must be sufficiently supported on the construction site and the slings must be spread above the package.

When exceeding a length of 7.5 m the profiles should not be handled by means of a forklift truck.

Up to a length of 10 m we recommend to use hoisting slings, for profiles with a length of more than 10 m the use of a suitable cross beam with hoisting slings.

When slinging it must be ensured that the edges of the profiles are not damaged by the hoisting slings (e.g. by using suitable edge protection). When handling the profiles on the construction site they must be lifted from the stack and carried on edge by at least 2 persons to the place of installation.

To avoid damages to the high-quality surface the profiles must not be pulled over other profiles already installed or sharp edges.

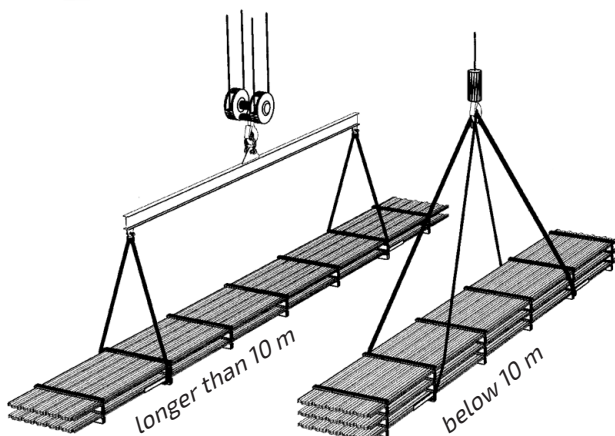
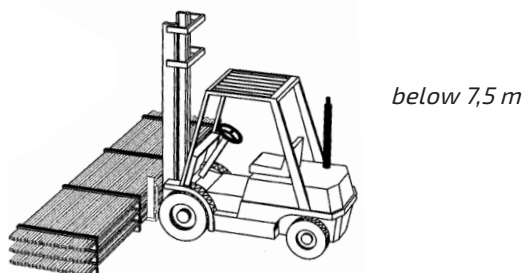

Storage

When being temporarily stored on the construction site the construction elements must be placed slightly inclined in the longitudinal direction.

Packages stored outdoors must be covered by rain-proof, well rear-ventilated tarpaulins. If moisture penetrates the packages the panels are immediately to be separated. Otherwise there is the risk of formation of white rust (zinc hydroxide) on steel surfaces within a very short time; aluminium panels may be affected by blackening which cannot be removed without permanent changes to the surface. When being stored for a longer period all types of profiles are to be stored at a roofed area.

Package wrappings provided by the manufacturer (such as foils) must be opened to prevent water condensation. This is only a transport packaging!

Uncoated material, i.e. galvanised steel or bare aluminium must not be stored outdoors.

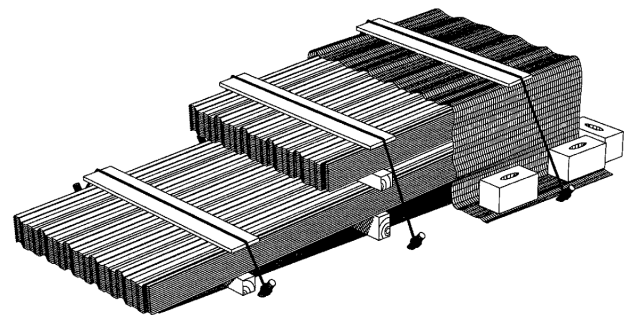

Protective Foil

On request the profiles are supplied with protective foil. The foils are normally not UV-resistant and should be immediately removed during installation, as otherwise the foil cannot be removed from larger areas after longer exposure to the weather and longer periods of time.

The protective foil should be removed at a material temperature of at least + 10° C to avoid any adhesive residues.

If the protective foil is removed too late residues can be removed by isopropanol.

Preparation for Installation

Prior to installation all dimensions must be checked at the building. Before starting the installation the existing substructure must be checked for stability, accuracy and suitability (compatibility of materials); it is absolutely necessary to level out any unevenness. Aligning is an important preparatory work and facilitates the installation very much.

Substructure

If coniferous wood is used for the substructure it should at least meet the requirements of the strength class C24 according to DIN EN 338 and DIN EN 14081-1, or strength grading class S10 according to DIN 4074-1.

Distances of Support and Aligning

At the eaves, the profiles may have a maximum free, unsupported projection of 200 mm without any special documentation. This projection, however, should not exceed 70 mm at the ridge and the verge.

Aligning starts with the determination of the orientation of the eaves. The orientation of the eaves must be parallel to the orientation of the ridge. Its distance to the lowest purlin is determined by the intended projection of the roof and the maximum permissible free projection. The profiles are installed in right angles to these lines. The first lining right-angled to the orientation of the eaves results from the desired projection at the gable and maximum permissible free lateral projection.

If it now turns out that the projection of the verge becomes irregular as the existing building is not at right angles verge flashings can be used for compensation. From the verge the first lining out is done in accordance with the panel width.

The further lining outs are at the respective effective width = cover width.

Installation Direction and Order

In the roof and wall area the profiles are installed against the main weather direction. This makes the covering even safer. When installing with a transverse joint, first a continuous row from the eaves to the ridge is installed before starting the next row at the eaves. If a symmetrical arrangement of profiles to a door or window aperture is intended in the wall area, this aperture must be precisely determined in advance and the profiles must then be carefully arranged.

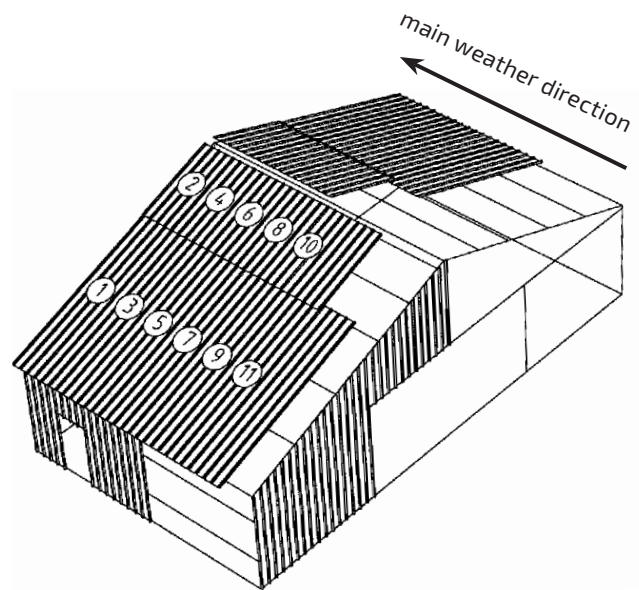

Cleaning and Repair

Any contamination of the high-quality coatings should be avoided as far as possible by proper storage and installation. If any soiling has nevertheless occurred the dirt should be removed in a fresh state by using a mild soap solution and ample rinsing with clear water.

If smaller areas of the coating are damaged it is sufficient to repair them with a touch-up paint provided by us. If the zinc coating is badly damaged a commercial zinc-rich primer must be applied first. In case of major damages we recommend to replace the profiles.

Translucent Roofing Panels

PVC translucent roofing panels are to be stored on a dry, level surface and covered with a light, optically opaque tarpaulin against solar radiation. The packaging provided by the manufacturer serves as transport packaging only. For translucent roofing panels, the distance of supports is smaller than the one for trapezoidal panels and is up to 1,000 mm max. depending on the shape of the profile.

All surfaces of the supports (both purlins and surfaces of trapezoidal profiles covered by translucent roofing panels) must be light. We recommend to use a white or aluminium coloured adhesive tape. The width of the support should not be less than 50 mm. According to the profiles the side overlap is the height of the crest. Translucent roofing panels expand by approx. 4 mm/m at a temperature difference of 50°C.

Roof: Profiled roofing sheets made of plastic must be fixed at the top chord on principle by using saddle washers. Depending on the panel length, the bore hole must be predrilled with a hole correspondingly larger. Per meter of panel length the bore hole must be drilled 1mm larger than the diameter of the screw shaft (e. g. for a panel length of 6 m and a diameter of the screw shaft of ~ 5 mm a bore hole of 11 mm must be predrilled in the translucent roofing panel). The maximum diameter of the bore hole in the translucent roofing panels should not exceed 14 mm.

In any case we recommend to install spacers. Fastening is normally carried out at every second chord. At the edges and the transverse joints of the installation area fasteners must be attached at every crest.

Wall: The wall installation of plastic panels is carried on the respective bottom chord. Depending on the panel length, the bore holes must also be predrilled with a hole correspondingly larger. Screws with sealing washers $\varnothing > 19$ mm should be used. Attention, the screws must not be overtightened.

When translucent roofing panels are connected sufficient space for expansion must be provided. To avoid heat accumulation sufficient aeration and ventilation must be ensured when using translucent roofing panels.

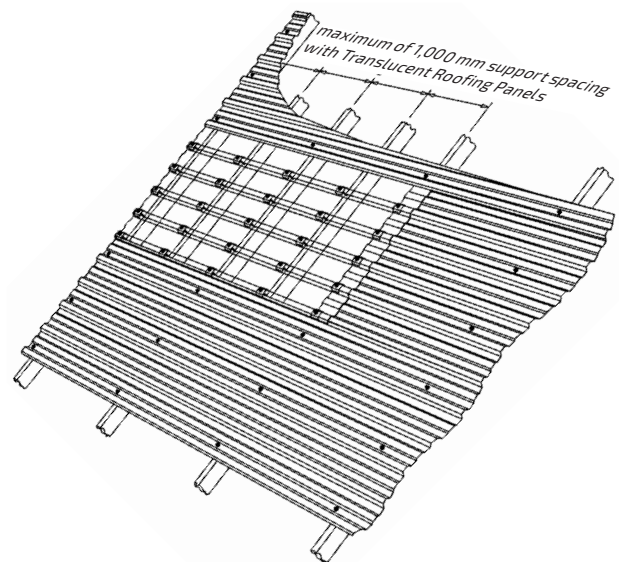

Ridges

The different types of buildings and their utilization result in a variety of ridge designs. The standard ridges shown below stand for a variety of ridge designs. Please, contact us to find an optimal solution for your individual requirements.

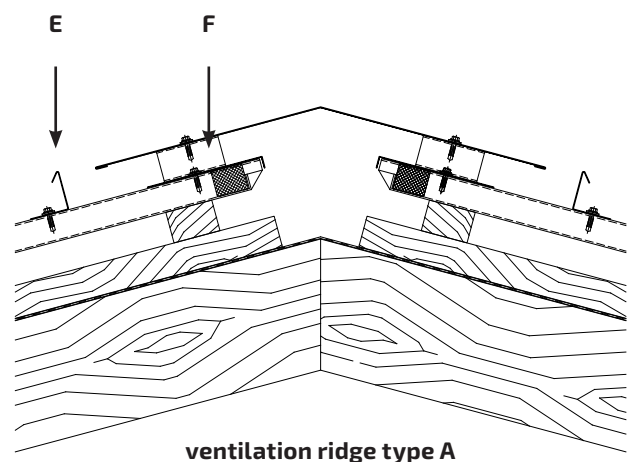
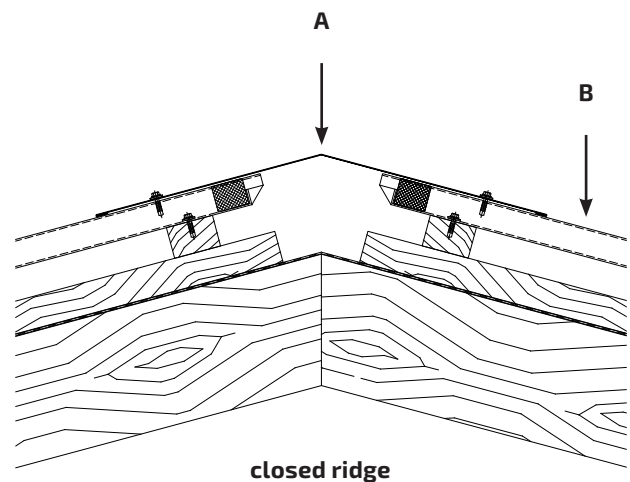

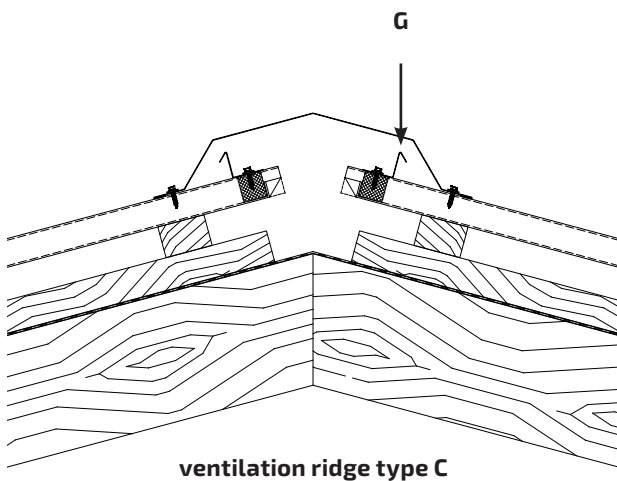
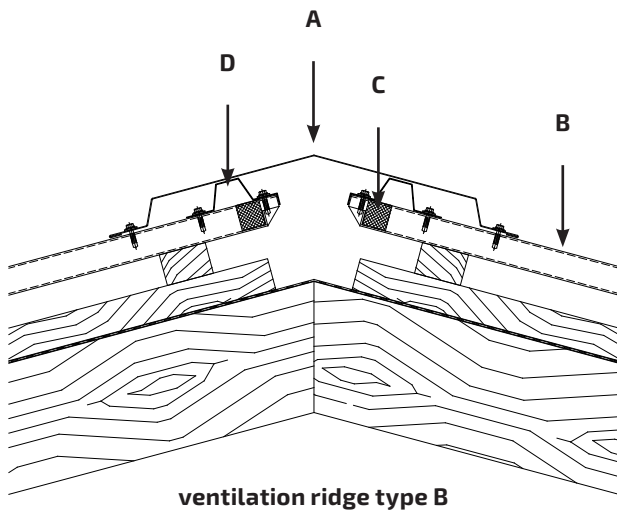

- A: ridge
- B: roof covering
- C: profile filler
- D: support angle made of perforated metal plate
- E: wind deflecting plate
- F: TRP 40 -100 with supporting metal sheet
- G: deflecting profile

Wall Installation

The exact aligning has already been mentioned in the chapter **Distances of Supports and Aligning** (p.7) and is required to the same extent for wall installation. Before aligning it is advantageous to check the grid dimension of the panels and the planned design to be able to react to any tolerances directly at the beginning of the installation.

The pattern of the screws should be exactly checked by means of a plumb line. The overlap of the transverse joint of the wall should be at least 150 mm.

Arrangement of Profiles

Due to the colour coating and/or the direction of rolling of bare materials the profiles must always be installed in one direction, otherwise differences in colour may appear.

Shaped Parts and Detailed Solutions

In addition to our range of standard parts a variety of special flashings can be produced. If you have any questions regarding the professional execution of detailed aspects, the installation of windows and roof-light domes or the like, please ask for our proposals for solutions or contact our field staff.

Mounting at the Verge and the Ridge

Verges, ridges and other shaped parts are mounted at the profiles by means of screws for shaped parts. The appropriate screws for wood and metal joints are listed at the end of our installation instructions. Because of the temperature-dependent expansion of metal only the parts outside the overlap area may be screwed down. At verges and ridges the optimum overlap is 100 mm. For a proper sealing profile filler with filling part or pre-compressed sealing tapes are inserted at the overlapping area.

Processing Steel Profiles

Cut-outs and fittings should be made by a nibbler or a jig saw. It is strictly forbidden to use angle grinders as the high cutting temperatures burn the zinc and lacquer coating on either side of the cut so that no corrosion preventive system can be built up. After installing drilling chips and sawdust must be **immediately** and carefully removed.

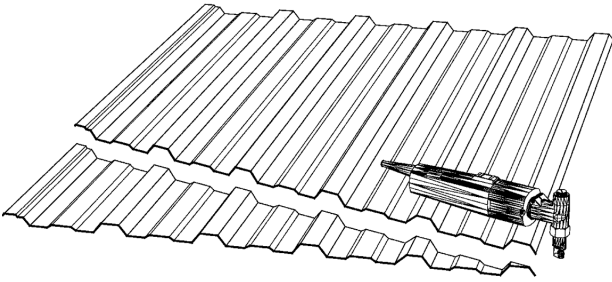

Longitudinal Joints

The water trap profiled into some trapezoidal steel profiles largely prevents water from penetrating into the interior of the building by capillary attraction. Panels must be connected in the longitudinal joints within the installation area by non-corroding and approved fastening elements. The distance in the roof must not exceed 500 mm and in the wall 666 mm. For roof pitches of $< 10^\circ$ a continuous suitable sealing must be provided. Longitudinal joints at wall outer shells are carried out without sealing tapes.

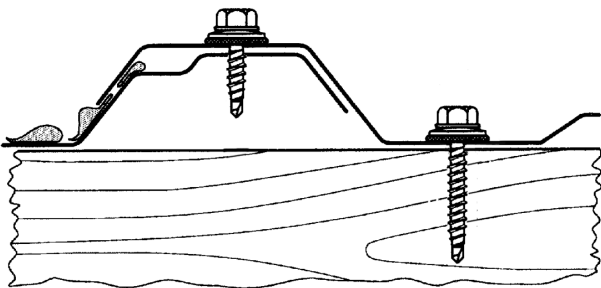

In no case silicone should be used for sealings!

Transverse Joints

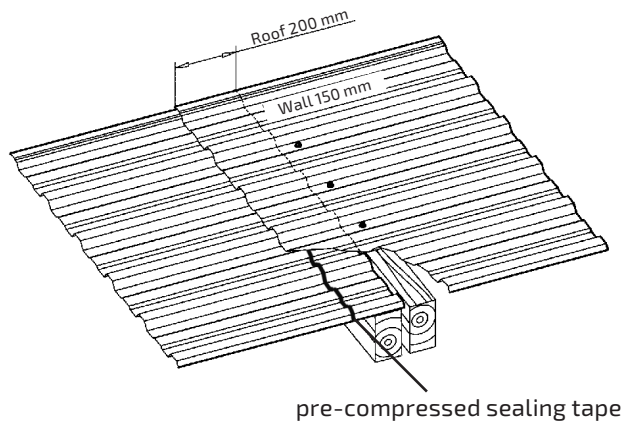
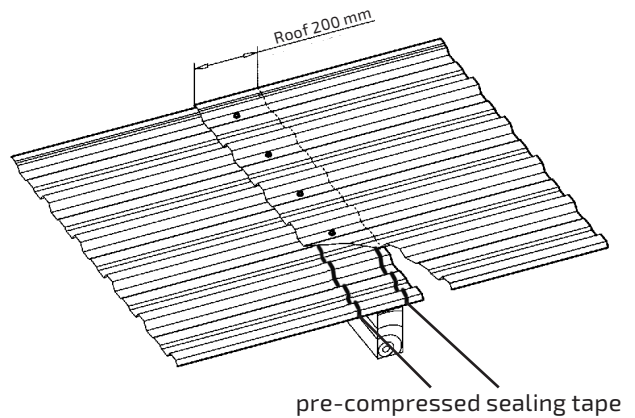

Transverse joints of steel profiles must be arranged on a support on principle. With a profile length of up to 7 m profiles can be butted on a beam or cross beam. The fastening is carried out at every top or bottom chord. The overlap in the roof area is at least 200 mm, for roof pitches of $> 12^\circ$, 150 mm are sufficient. To avoid any distortions and the formation of slotted holes in the area of the fastening elements, profiles with a length exceeding 7 m are mounted with a sliding joint. The fastening is carried out at every top or bottom chord. Pre-compressed sealing tapes are inserted in the overlapping area.

In no case silicone should be used for sealings!

Specific Instructions

Trapezoidal profiles made of aluminium must not come into contact with untreated steel or copper. In such cases, a separating layer made of bitumised board is as suitable as a bituminous coating or the like. There are no objections when installing trapezoidal aluminium profiles on galvanised steel, untreated wood (we recommend a separating layer, when using impregnated wood this layer is mandatory) or regarding the contact with zinc, tin, lead, plastics or stainless steel. Alkaline materials (lime, mortar, sodium bicarbonate, ammonia or similar substances) must not come into contact with aluminium. To clean dirty aluminium profiles water, perhaps after adding detergents (max. 5%) or cleaning solvents (max. 10 %) should be used. For minor paint damages touch-up paints (air-drying) are available. Due to the alternation of length, trapezoidal profiles made of aluminium must not exceed a maximum length of 10 m depending on the colour shade.

Processing Aluminium Profiles

In order to cut aluminium panels, hand-held circular saws with coarse toothed, carbide-tipped saw blades, electric nibblers or jig saws are to be used. Separating in longitudinal direction can also be done by means of a scriber or knife (scoring at a profile bend, then separating by bending back and forth for several times). If the panels shall be cut by an angle grinder a special cutting disc must be used!

Bare aluminium may only be processed when wearing gloves!

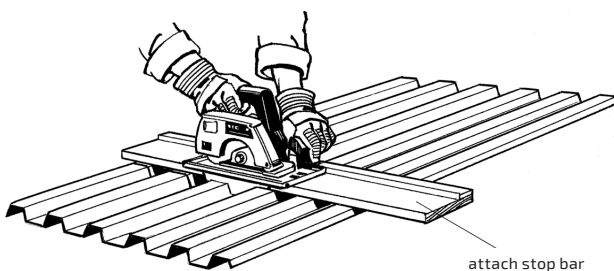

Roof Pitch

The minimum roof pitch depends on the width of the roof, height of the profile, number of transverse joints and roof penetrations. Without any transverse joints and roof penetrations, the minimum roof pitch is 3 - 5°. Transverse joints and roof penetrations in the roof area are permissible from a roof pitch of 5° to 7° when using suitable sealing tapes. The standard roof pitch for roofs with profiled panels is 7° (see IFBS-rules of metal lightweight construction).

Longitudinal Joints

For the profiles TRP 20-75 and TRP 40-100 a connection at the longitudinal joint is not necessary if the distance between the purlins is ≤ 1.5 m. A fastening must always be carried out directly next to the longitudinal joint. For other profiles a connection at the longitudinal joint may be required (see page 8). In no case silicone should be used for sealings!

Transverse Joints

Transverse joints of aluminium profiles must be arranged on a support on principle. With a profile length of up to 6 m profiles can be butted on a beam or cross beam. The fastening is carried out at every top or bottom chord. The overlap in the roof area is at least 200 mm, in case of roof pitches $> 17^\circ$ 150 mm are sufficient. To avoid any distortion and the formation of slotted holes in the area of the fastening elements, profiles with a length exceeding 6 m are mounted with a sliding joints. The fastening is carried out at every top or bottom chord. In the overlapping area pre-compressed sealing tapes are inserted. In no case silicone should be used for sealings!

Accessibility and Safety

When taking due care you can walk on an aluminium roof. The accessibility is directly related to the shape of the profile, the material thickness and the span. Prerequisites are appropriate footwear, walking in the area of the beams, weight of the persons etc. For safety during installation, the accident prevention rules for operations at and on roofs must be observed.

Attention: Please see DIN EN 1991-1 for the individual application!

Fixing Patterns for Trapezoidal and Corrugated Profiles / Roof and Wall (lower edge - distance up to max. 1.0 m)

Arrangement of Fastening Elements

The stress on the wall and roof areas of a building is higher in the peripheral areas than on the other surfaces. Depending on the height of the building and a distance between the cross beams and the purlins respectively of up to max. 1.0 m, this results in various possibilities regarding the arrangement of screws for the profiles which are shown here schematically for the respective profile (edge region and normal region).

The distance between the purlins depends on the local conditions such as snow and wind loads. In order to determine the respective distance between the purlins load tables are to be used.

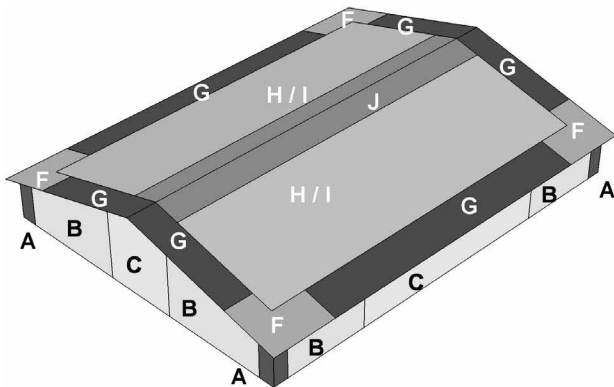

The figure given above shows the roof and wall areas according to DIN EN 1991-1-4 (dimensions depending on the geometry of the building).

Fastening at the Bottom Chord

At first the profiles should be screwed at the bottom chord next to the overlap to fix the position of the profile at its best before final fastening. We do not recommend a screw connection in the trough when using corrugated profiles in the roof.

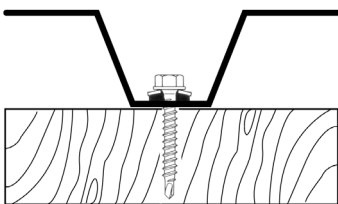

fastening without saddle washer with self-drilling screw (double thread)
(from 0.63 mm material thickness)

Fastening at the Top Chord

At first the profiles should be screwed in the longitudinal joint to fix the position of the profile at its best before final fastening. Only fastening elements and dowels approved by the construction supervision agencies are allowed to be used while taking the appropriate corrosion protection into account. When screwing the profiles down it must be ensured that the sealing washer of the screws does not project more than 1.0 mm above the washer. The screws must not be overtightened (see IFBS-rules of metal lightweight construction).

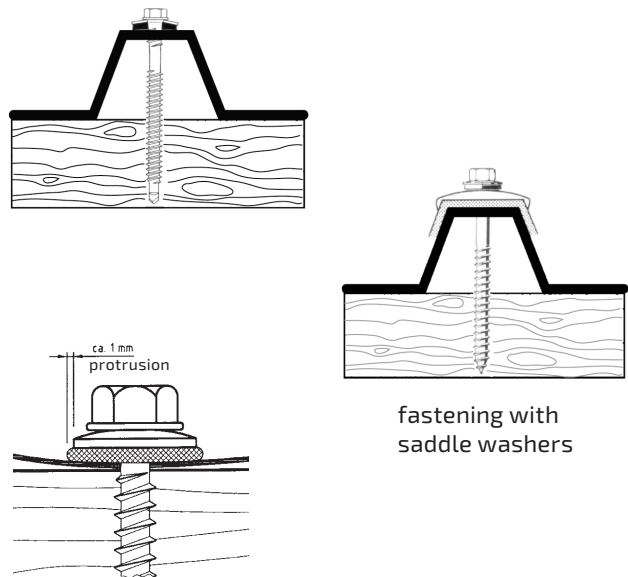

fastening with saddle washers

Attention:

When fastening in the top chord by using saddle washers, it must always be noted for all profiles that in case of wooden substructures the position of the screw must be predrilled in the wood with a drill having a diameter of „approx. 0.7 x diameter of the screw“ (approx. 4.5 mm when using a screw \varnothing 6.5 mm). The profiles (TRP and corrugated panel) must also be predrilled with a diameter of approx. 9 mm and are bolted down in the top chord (crest) by means of a screw 6.5 x 90 mm or respectively longer (depending on height of the profile + saddle washer). Alternatively, self-drilling screws 5.5 x 95 mm (or correspondingly longer depending on the height of the profile) with support thread without saddle washers can be used; this applies only to steel with a material thickness of ≥ 0.63 mm. For distances between the purlins exceeding 1.5 m a screw connection at the longitudinal joint is required! When fastening by means of a self-drilling screw of fastening by drilling screws in the bottom chord (wall profile) pre-drilling is not necessary.

Fixing Patterns

Attention: Please see DIN EN 1991-1 for the individual application!

Top chord

Trapezoidal Profile 20 - 75

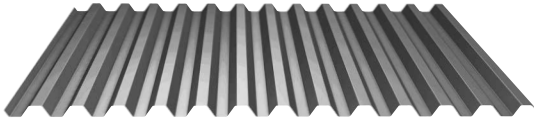

edge region and ridge beam



normal region



Bottom chord

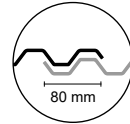

At the normal region, fastening must be done alternately (a / b) according to the sketch.

edge region and ridge beam

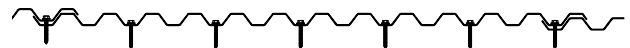

normal region



Trapezoidal Profile 40 - 100

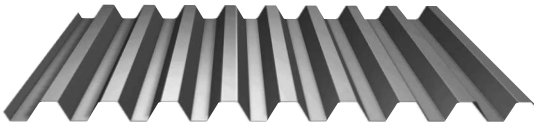

edge region and ridge beam



normal region

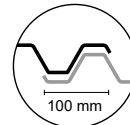
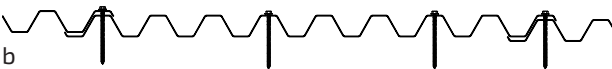
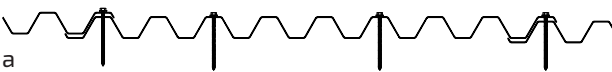

At the normal region, fastening must be done alternately (a / b) according to the sketch.

edge region and ridge beam

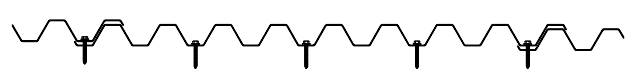

normal region

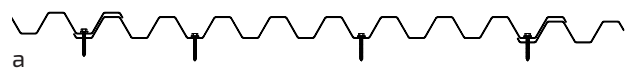

Trapezoidal Profile 18 - 224 Wall Profile

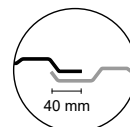
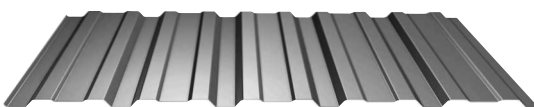

At the normal region, fastening must be effected according to the sketch.

edge region and normal region

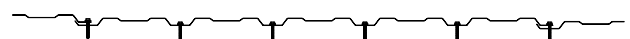

A screw connection is required for the longitudinal joint according to static requirements and structural conditions respectively.

Fixing Patterns

Attention: Please see DIN EN 1991-1 for the individual application!

Top chord

Trapezoidal Profile 22 - 214

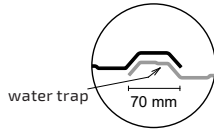
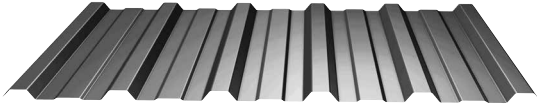

At the normal region, fastening must be done alternately (a / b) according to the sketch.

edge region and ridge beam

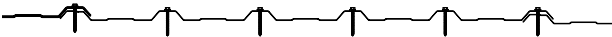

normal region

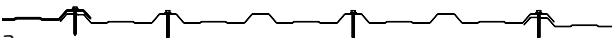

Bottom chord

edge region and ridge beam

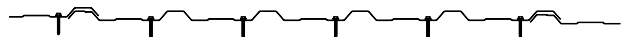

normal region

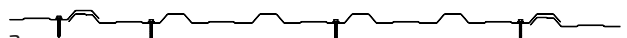

Trapezoidal Profile 35 - 207 Roof Profile

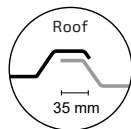
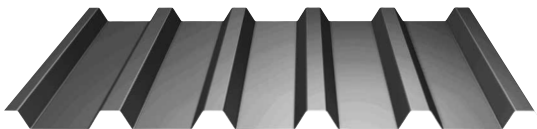

At the normal region, fastening must be done alternately (a / b) according to the sketch.

edge region and ridge beam

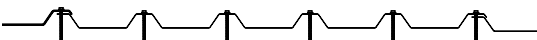

normal region

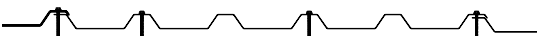

edge region and ridge beam



normal region



Trapezoidal Profile 35 - 207 Wall Profile

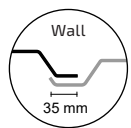
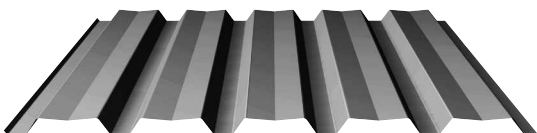

At the normal region, fastening must be done alternately (a / b) according to the sketch.

edge region



normal region



A screw connection is required for the longitudinal joint according to static requirements and structural conditions respectively.

Fixing Patterns

Attention: Please see DIN EN 1991-1 for the individual application!

Top chord

Trapezoidal Profile 45 - 333 S

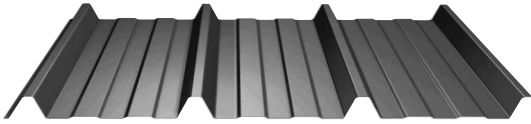

edge region and normal region

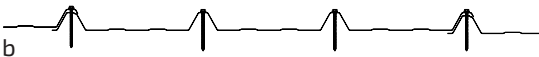
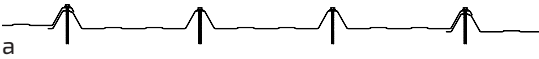

Bottom chord

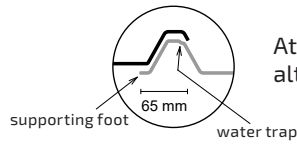

At the normal region, fastening must be done alternately (a / b) according to the sketch.

edge region and normal region

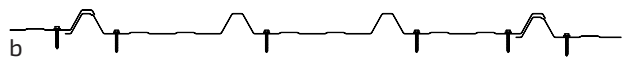
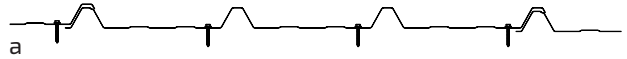

ridge beam

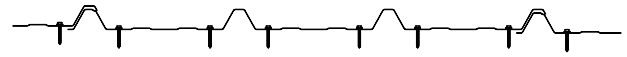

Trapezoidal Profile 50 - 250 Roof Profile



edge region and ridge beam



normal region

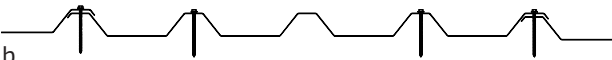

At the normal region, fastening must be done alternately (a / b) according to the sketch.

edge region and ridge beam

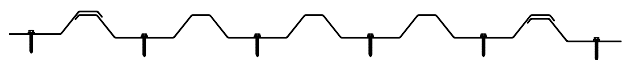

normal region

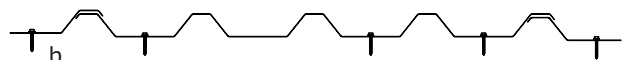
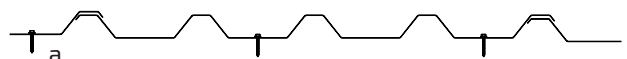

A screw connection is required for the longitudinal joint according to static requirements and structural conditions respectively.

Fixing Patterns

Attention: Please see DIN EN 1991-1 for the individual application!

Top chord

Bottom chord (for wall only)

Corrugated Profile 18 / 76

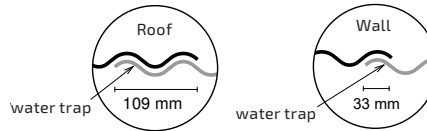
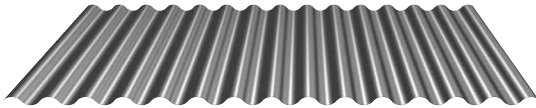

At the normal region, fastening must be done alternately (a / b) according to the sketch.

edge region and ridge beam



normal region



edge region and ridge beam



normal region



Corrugated Profile 27 / 111

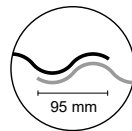
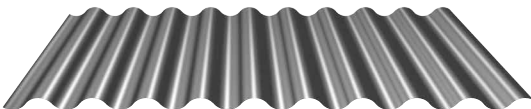

At the normal region, fastening must be done alternately (a / b) according to the sketch.

edge region and ridge beam



normal region



edge region and ridge beam



normal region



A screw connection is required for the longitudinal joint according to static requirements and structural conditions respectively.

Fixing Patterns

Attention: Please see DIN EN 1991-1 for the individual application!

Top chord

Corrugated Profile 42 / 160

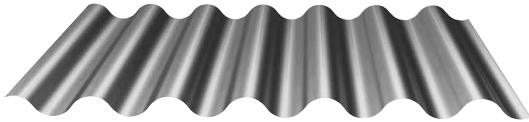

edge region and ridge beam



normal region

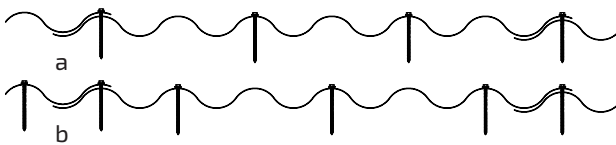

Bottom chord (for wall only)



At the normal region, fastening must be done alternately (a / b) according to the sketch.

edge region and ridge beam



normal region

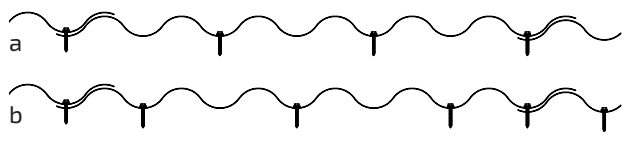

Corrugated Profile 55 / 177

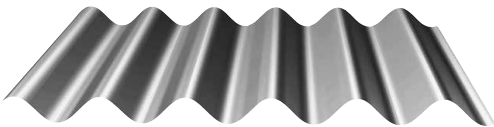

edge region and ridge beam



normal region

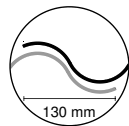
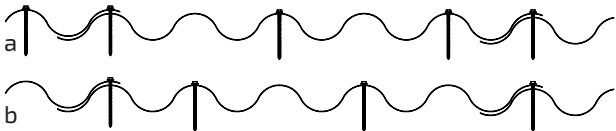

At the normal region, fastening must be done alternately (a / b) according to the sketch.

edge region and ridge beam



normal region

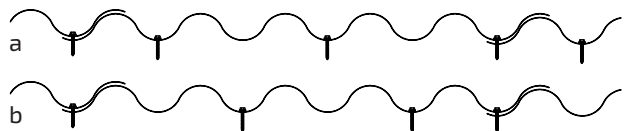

A screw connection is required for the longitudinal joint according to static requirements and structural conditions respectively.

Fastening at the top chord

Mounting on wood

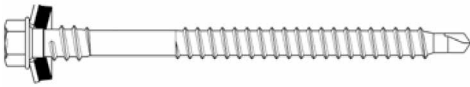

stainless steel self-drilling screw
Ø 6,0 x 78 - 228 mm

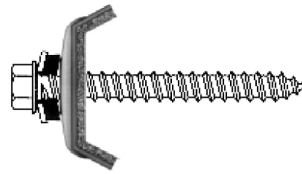

stainless steel screw
Ø 6,5 x 65 - 200 mm with aluminium saddle washer



Mounting on steel

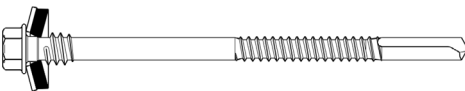

stainless steel self-drilling screw
Ø 5,5 x 69 - 282 mm

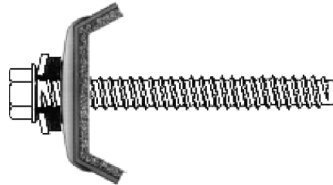

stainless steel screw
Ø 6,3 x 65 - 200 mm with aluminium saddle washer

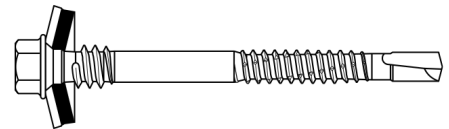

stainless steel self-drilling screw
Ø 5,5 x 76 - 289 mm

Screws for longitudinal joints / shaped parts

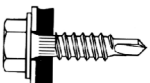

steel, galvanised,
screw for shaped part
Ø 4,8 x 20 mm

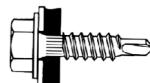

stainless steel,
screw for shaped part
Ø 4,8 x 20 mm

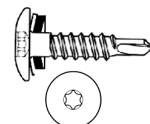

stainless steel,
screw for shaped part
Ø 4,8 x 20 mm, with torx

Special fasteners

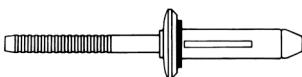

aluminium-folding leg blind rivet
Ø 5,2 x 17,5 - 41,3 mm

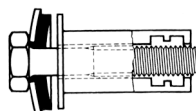

stainless steel overlap blind rivet
Ø 9,5 x 25 mm

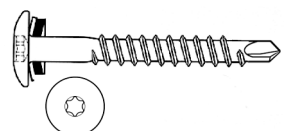

stainless steel,
self-drilling screw
Ø 4,8 x 35 mm, with torx

Fastening at the bottom chord

Mounting on wood

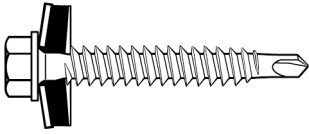

stainless steel self-drilling screw
Ø 6,5 x 40 mm

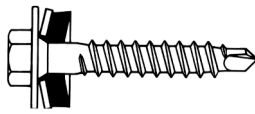

stainless steel self-drilling screw
Ø 4,8 x 35 mm

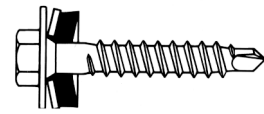

steel, galvanised screw
for shaped parts Ø 4,8 x 35 mm

Mounting on steel

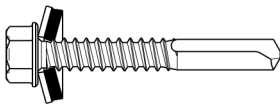

stainless steel self-drilling screw
Ø 5,5 x 40 mm

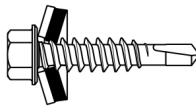

stainless steel self-drilling screw
Ø 6,0 x 29 mm

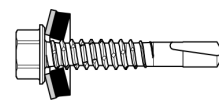

stainless steel self-drilling screw
Ø 5,5 x 31 mm

Screws for longitudinal joints / shaped parts

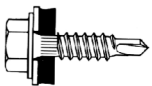

steel, galvanised,
screw for shaped part
Ø 4,8 x 20 mm

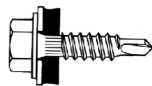

stainless steel,
screw for shaped part
Ø 4,8 x 20 mm

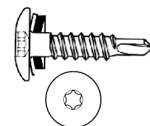

stainless steel,
screw for shaped part
Ø 4,8 x 20 mm, with torx

Special fasteners

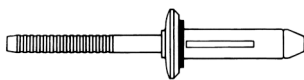

aluminium-folding leg blind rivet
Ø 5,2 x 17,5 - 41,3 mm

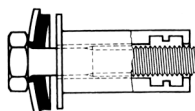

stainless steel overlap blind rivet
Ø 9,5 x 25 mm

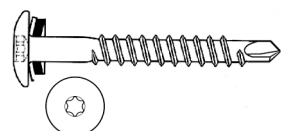

stainless steel,
self-drilling screw
Ø 4,8 x 35 mm, with torx

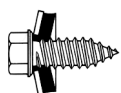

stainless steel repair screw
Ø 7,1 x 19 mm

Trapezoidal and Corrugated Profiles

Hans Laukien GmbH
Borsigstraße 23
24145 Kiel
Tel.: +49 431 7187-0
Fax: +49 431 7187-250
Headquarters - Production - Sales

Pappelweg 2
39288 Burg
Tel.: +49 3921 9384-0
Fax: +49 3921 9384-650
Production - Sales

www.laukien.de
verkauf@laukien.de

